

How To Make A Reverse Onbuhimo

You Need:

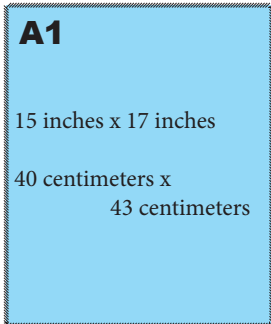

A1

15 inches x 17 inches
40 centimeters x
43 centimeters

This fabric is:

without any stretch
thick like men's pants
natural fibers like cotton or linen
machine washable

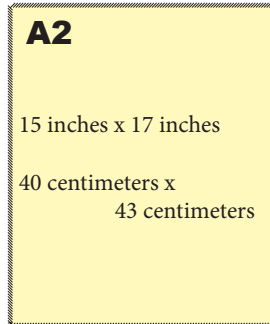

A2

15 inches x 17 inches
40 centimeters x
43 centimeters

This fabric is:

without any stretch
VERY thick like a strong bag
natural fibers like cotton or linen
machine washable

(This fabric will not be seen when finished)

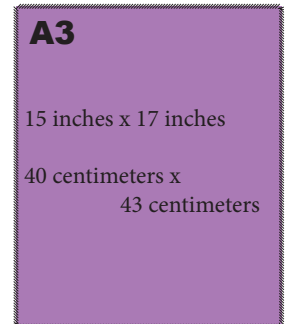

A3

15 inches x 17 inches
40 centimeters x
43 centimeters

This fabric is:

pretty!



60 inches x 15 inches
150 centimeters x 40 centimeters

B1



60 inches x 15 inches
150 centimeters x 40 centimeters

B2

This fabric is:

without any stretch
thick like men's pants
natural fibers like cotton or linen
machine washable



C1



C2

Both C1 & C2:

5 inches x 6 inches
12 centimeters x 15 centimeters

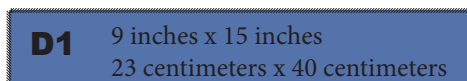

D1 9 inches x 15 inches
23 centimeters x 40 centimeters

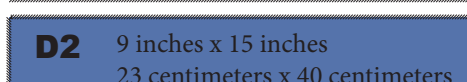

D2 9 inches x 15 inches
23 centimeters x 40 centimeters

C & D fabrics are:

without any stretch
thick like men's pants
natural fibers like cotton or linen
machine washable

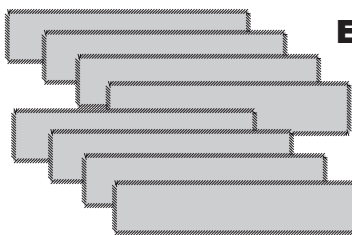

E1 - E8

E1, E2, E3, E4, E5, E6, E7 & E8:
3.5 inches x 10 inches
9 centimeters x 25 centimeters

E1 - E8 fabrics are:

fleece
soft & fluffy
thick like a warm blanket

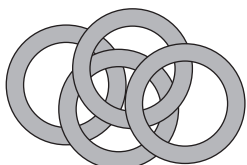

4 small aluminum rings
2 inch inner diameter
5 centimeter inner diameter
weight tested, without seams

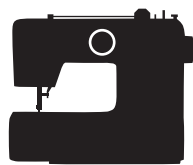

Sewing Machine



Thread

Regular All Purpose
100% Polyester



Sewing Machine Needle

Heavy Duty or Denim Needle

Symbols:

 raw, unfinished edge

 folded/finished edge

 sew here

 fold here

 stitching from previous steps

1)

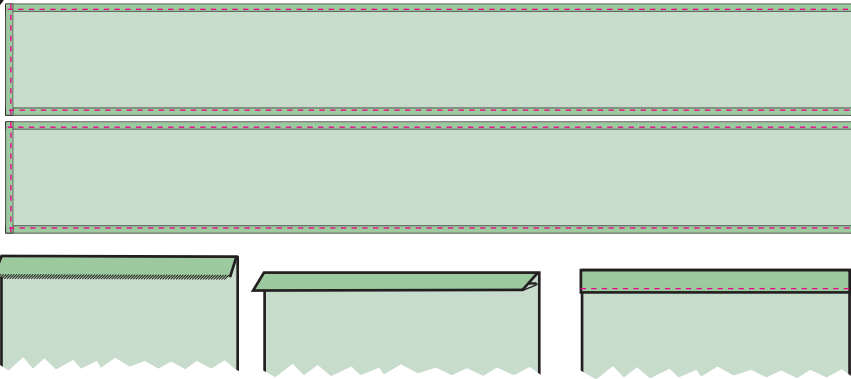

Hem both long edges and one short edge on **B1** and **B2**

To hem:

- Fold edge over 1/4 inch or 1 centimeter.
- Press flat.
- Fold edge again 1/2 inch or 1.5 centimeters.
- Press flat.
- Sew along inside fold.

2)

Cross section:

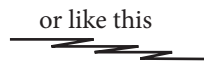
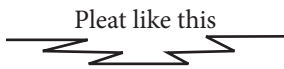

Pleat/fold raw short edge on **B1** and **B2** to reduce width to 4 inches/11 centimeters.

Stitch along raw edge & 4 inches/11 centimeters from edge to keep pleats in place.

3)

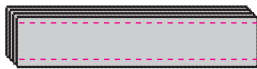

Stack **E1 - E4** neatly on top of each other with all edges lined up together.

Pin in place and stitch two lines down each side to keep all layers in place. Remove pins.

Stack **E5 - E8** neatly on top of each other with all edges lined up together.

Pin in place and stitch two lines down each side to keep all layers in place. Remove pins.

4)



Fold **D1** and **D2** in half lengthwise, right sides together.

Stitch along long raw edges to close into tubes, and down along one end to close it off.

5)

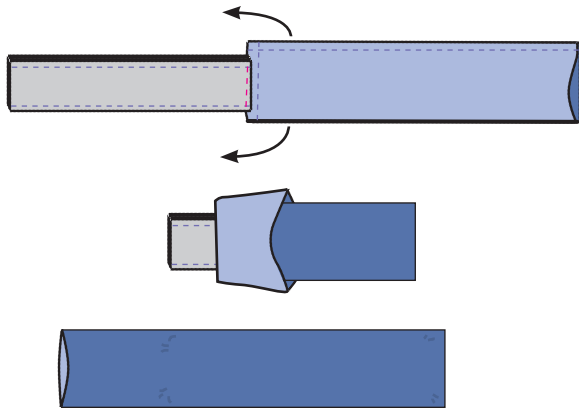

Sew the end of the **E1 - E4** stack to the excess seam allowance outside the closed end of **D1** with a few stitches.

Turn **D1** right side out, working it over the **E1 - E4** stack (like turning a pillowcase right side out around a pillow.)

In the end, **D1** should be right side out with the **E1 - E4** stack neatly inside of it.

6)

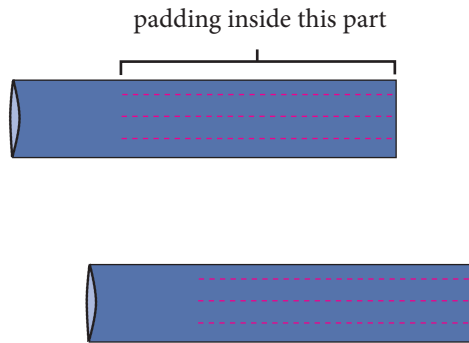

Repeat Step 5 with stack **E5 - E8** and **D2**.

Run a few lines of stitches down the length of **D1** and **D2** to secure internal padding in place.

7)

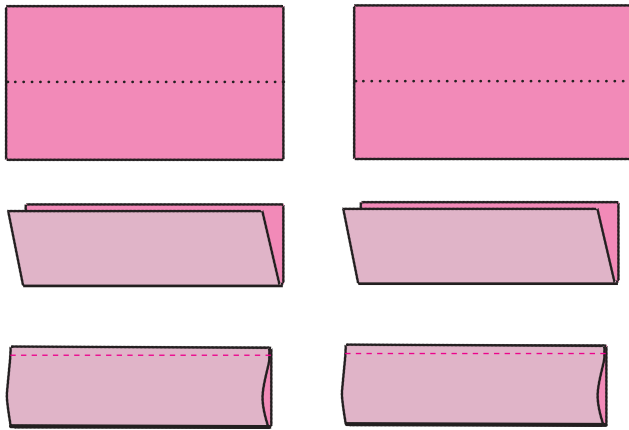

Fold **C1** and **C2** in half lengthwise, right sides together.

Stitch along long raw edges to close into tubes.

8)

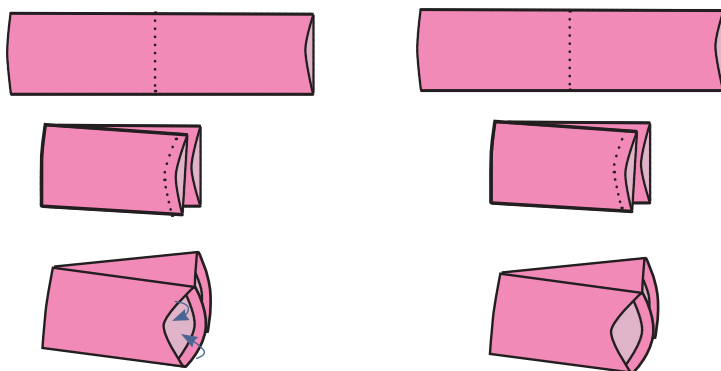

Turn **C1** and **C2** tubes right side out.

Fold in half width-wise and press flat.

Fold the raw ends to the inside of each end of each tube and press flat.

9)

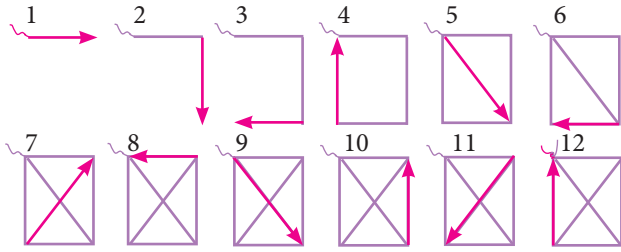
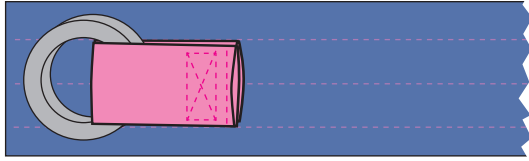

Thread 2 aluminum rings onto **C1** into the fold.

Pin **C1** to the padded, closed end of **D1**, with the rings even with the end of **D1**.

Run 1 line of stitching along the top of **C1** through all layers.

Remove pins.

Reinforce by sewing a narrow x-box on **C1** through all layers. Sew one continuous line of stitching without backstitching and tie the thread ends together in a double knot.

10)

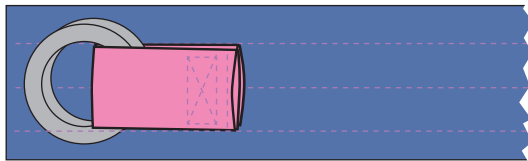
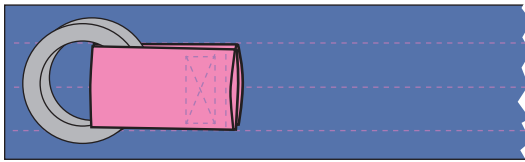

Repeat Step 9 to secure **C2** and the other 2 rings to **D2**.

11)

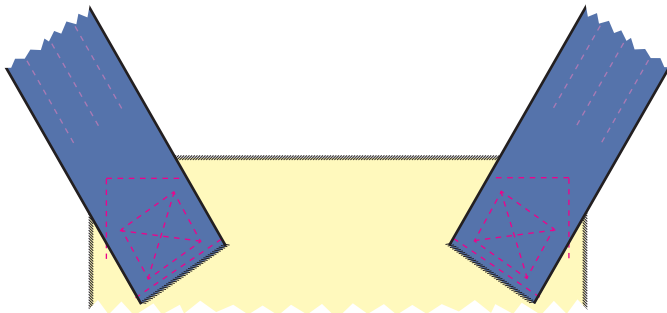

Lay the open, raw end of **D1** over the top left corner of **A2**, RING SIDE FACE DOWN, angled slightly outwards. **D1** should overlap **A2** by about 5 inches/12 centimeters. Pin in place.

Sew along the open end of **D1** and then 1 inch/2 centimeters inside of the corner of **A2** to secure **D1** in place.

Remove pins.

Reinforce with an x-box for reinforcement.

Repeat to secure **D2** to the top right corner of **A2**, RING SIDE FACE DOWN.

12)

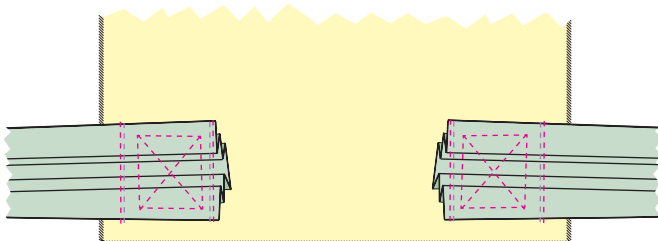

Lay unhemmed, pleated end of **B1** (right side DOWN) over the bottom left corner of **A2**, parallel to the bottom, about 1 inch/2 centimeters from the bottom edge, and overlapping **A2** by about 4 inches/11 centimeters. Pin in place while you sew.

Stitch 1 inch/2 centimeters from the left outside edge and again right along the raw unhemmed end of **B1**.

Remove pins and reinforce between these two lines of stitching with an x-box.

Repeat to secure **B2** (right side DOWN) over the bottom right corner of **A2**.

13)

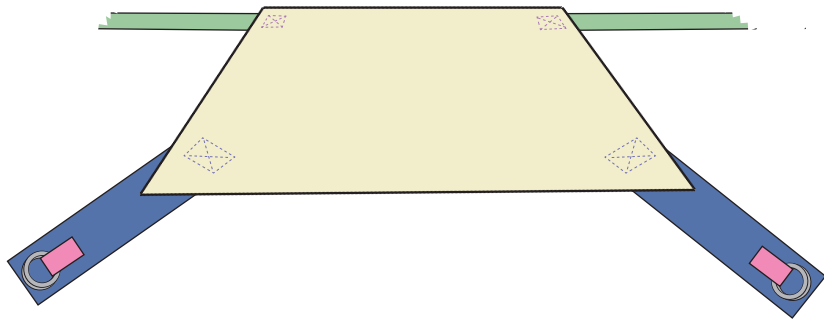

Turn **A2** over so that all **B** and **D** straps are all on the bottom side of **A2** with the **B** and **D** straps facing RIGHT SIDE UP. The rings should be on the TOP of **D1** and **D2**.

Optional: roll up the **B** straps and secure with rubber bands so they don't get in the way while sewing.

14)

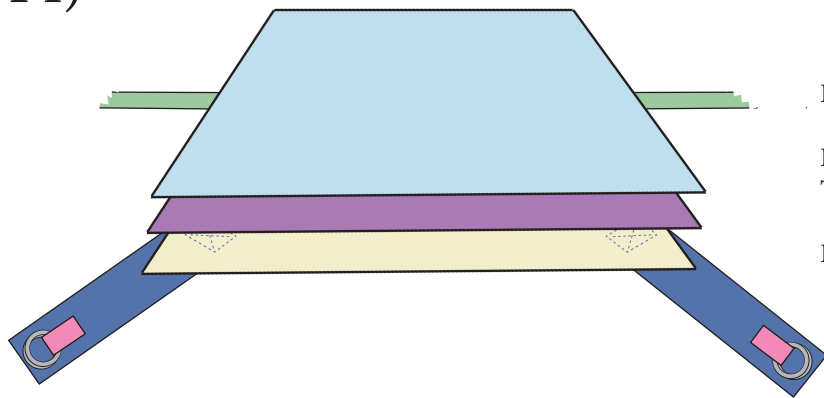

Lay **A3** on top, right side UP. This will be the visible layer.

Lay **A1** on top, right side DOWN.
This will be the layer against baby's back.

Pin around the edges to keep all three layers in place.

15)

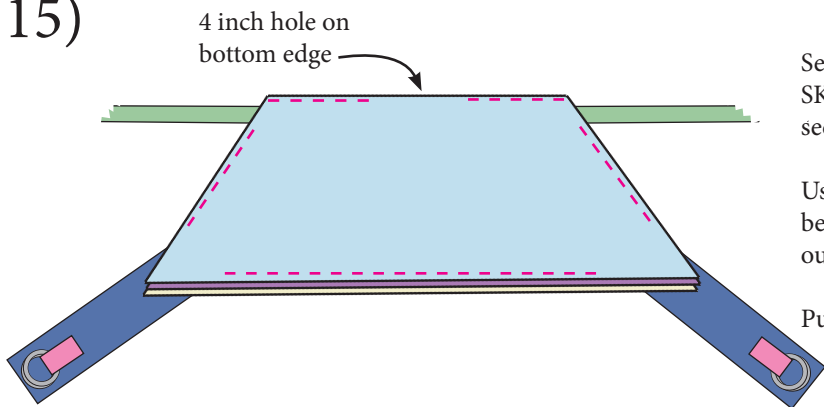

Sew around all four edges, 1/2 inch or 1 cm from the edge, SKIPPING OVER the straps and a 4 inch or 11 centimeter section at the bottom edge between the **B** bottom straps.

Using the 4 inch/11 centimeter hole at the bottom, reach between layers **A1** and **A3** and turn the carrier right side out, gently pulling everything through the bottom hole.

Pull each strap back out through its own hole.

16)

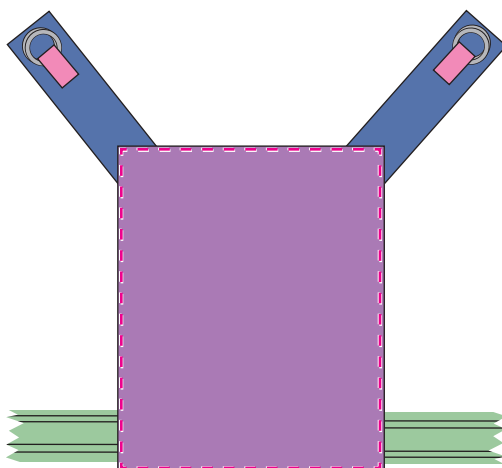

After turning the carrier right side out, press all edges flat.

Turn any raw edges under, press and pin.

Stitch around the entire outside edge, very close to the edge.

Finished!