

How to Convert a Meh Dai to a Traditional Fabric Loop Onbuhimo

Materials Needed:

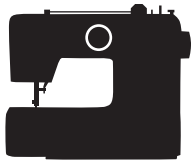

Sewing Machine

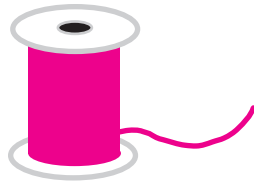

Thread

Regular All Purpose
100% Polyester
Quality Brand like Coats or Gutterman



Sewing Machine Needle

Heavy Duty or Denim Needle
Size 14 or 16

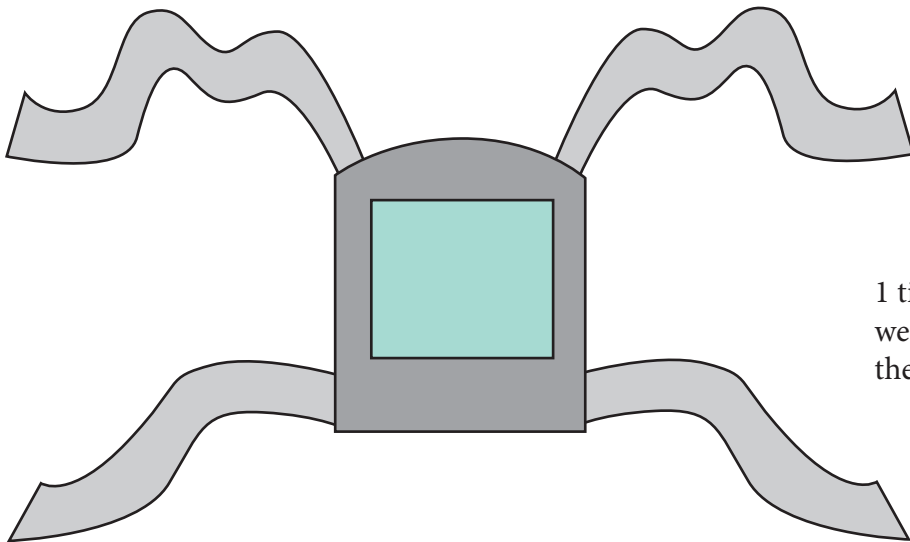

1 tie-waist meh dai that fits the intended wearee safely and comfortably with their arms out over the top of the carrier

1)

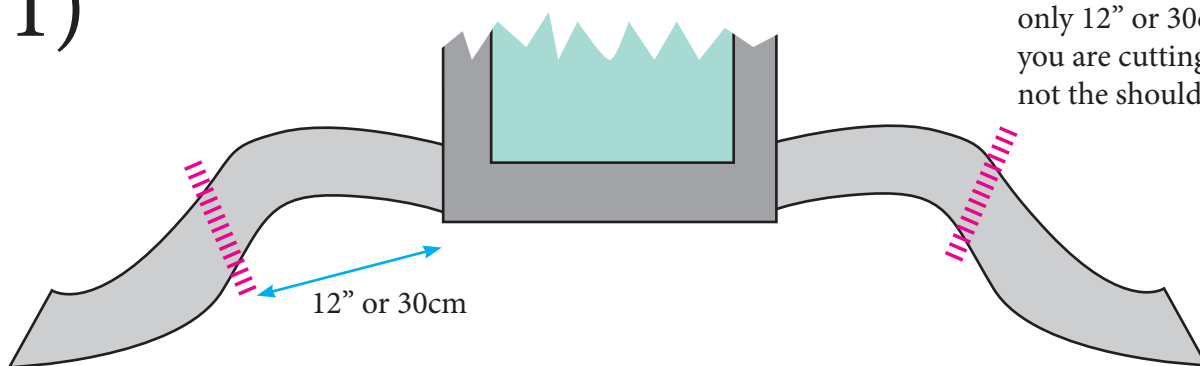

Cut both WAIST straps down to only 12" or 30cm long. Make sure you are cutting the waist straps, not the shoulder straps.

2)



Turn the carrier over so you are looking at the back (the side you cannot see when the child is in the carrier.)

3)



Fold about 1/2" or 1cm of the raw edge over and press it flat with an iron. (If you are working with two-layer hollow tube-like straps, you can turn the raw edge inside the strap and press.)

4)

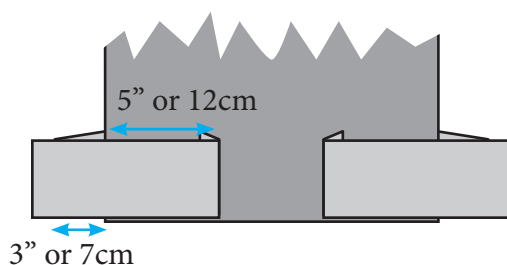

Fold each strap to the inside so that the cut end overlaps the body panel by about 5" or about 12cm. There should be about a 3+" or 7+cm loop left hanging over the sides of the body panel.

5)

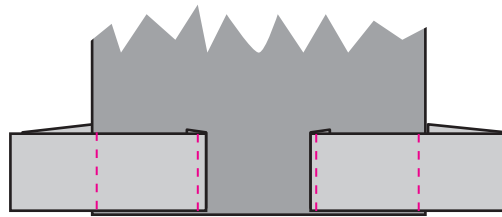

Secure each strap with a vertical line of straight stitches running along the edge of the body panel, and another straight line to secure the cut end and tack down the folded-under edge.

6)

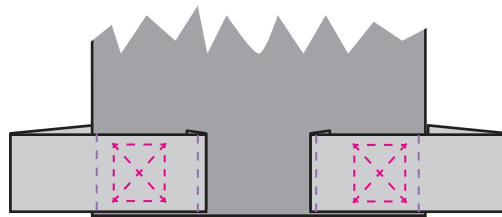

Reinforce each strap by sewing a continuous, 2-layer x box between each pair of lines.

Finished!

Sewing a 2-layer x box:

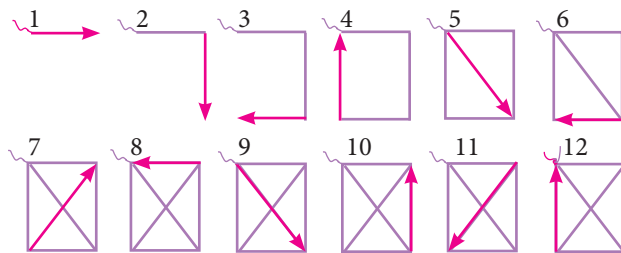

To secure the ends, either backstitch at the beginning and end of your x box, or leave your thread tails long and tie the two top threads and the two bobbin threads together in a square knot before cutting the ends off.